

# QUICK START GUIDE

Water Resistant RFID Access Control Reader

---

Applicable Model: ProID Series

Version: 1.2

Date: August 2023

# 1. Product Overview

## ProID101

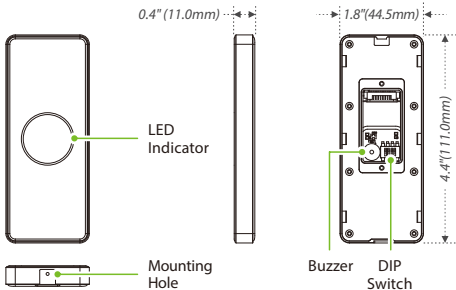

## ProID102

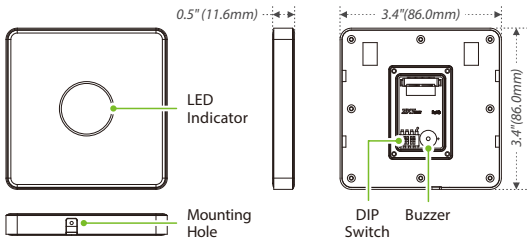

## ProID103

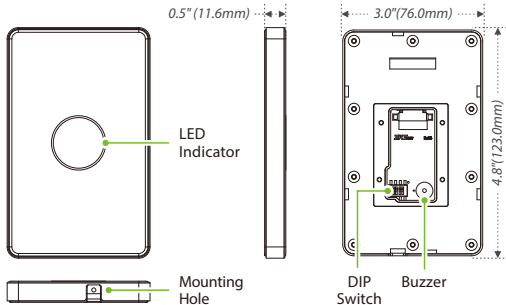

## Back Plate

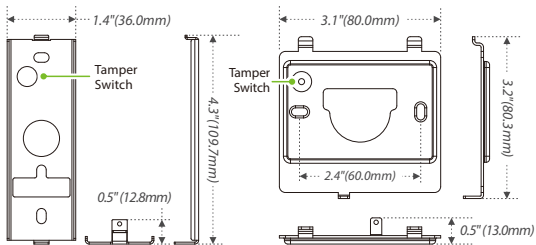

ProID101

ProID102

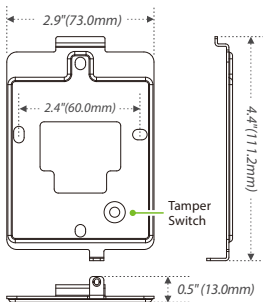

ProID103

## 2. Terminal Block

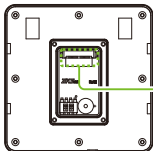

+12V		Power
GND		
WD1		Wiegand Out
WD0		
485A		RS-485
485B		
BUZ		Beep
LEDR		Red LED
LEDG		Green LED
W26/34		Wiegand 26/34
TAMPER		Tamper

## 3. Device Installation

### Install on the wall

- ① Attach the mounting template sticker to the wall, and drill holes according to the mounting paper.
- ② Secure the back plate on the wall with the wall mounting screws.
- ③ After passing the wires through the wiring hole and connecting them to the device, and then attach the device to the back plate from top to bottom.
- ④ Fasten the device to the back plate with a security screw.

**Note:** The installation method of ProID101 and ProID103 is the same as that of ProID102. Only ProID102 is used as an example, and will not be repeated here again.

①

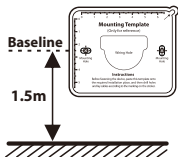

②

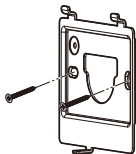

③

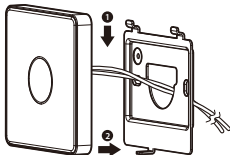

④

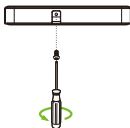

## Mounting on the wall through Asian gang box





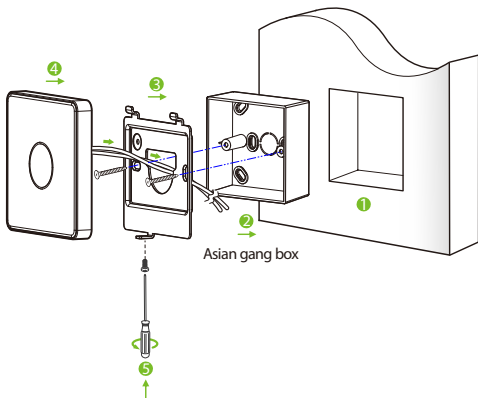

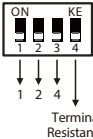

- ① Install the Asian gang box (or single gang box, mullion mount) into the wall.
- ② Fix the back plate onto the Asian gang box (or single gang box, mullion mount) using two wall mounting screws.
- ③ Pass the cables through the wire hole.
- ④ Then insert the device into back plate.
- ⑤ Use security screw to fasten the device to the back plate.

**Note:** The installation method of single gang box is the same as that of Asian gang box. Only Asian gang box installation method is illustrated as an example in this quick start guide.



## 4. DIP Switch Settings

As shown in the table below, places 1-3 of the DIP switch are used to set the device number for RS-485 communication, and place 4 is for setting the RS485 termination resistance. If the RS-485 communication wire is longer than 100 meters, it is needed to set the 4th DIP switch of the last reader to **ON** state, that is parallel a terminal resistance of 120 ohm between 485+ and 485-.

DIP Switch	485 Address	Switch Setting	485 Address	Switch Setting
	1		5	
	2		6	
	3		7	
	4		Terminal Resistance	

## 5. Standalone Installation

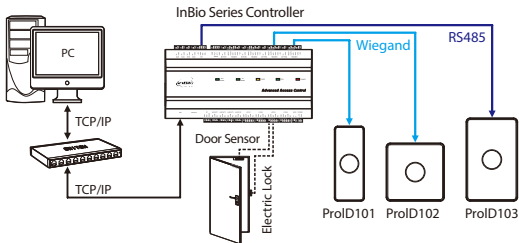

## 6. Controller Connection

This ProID series reader needs to be connected to a host machine in order to transmit card information via RS-485 or wiegand. The following is an example of the connection to InBio Series controller.

### ❖ Connect the controller via RS485

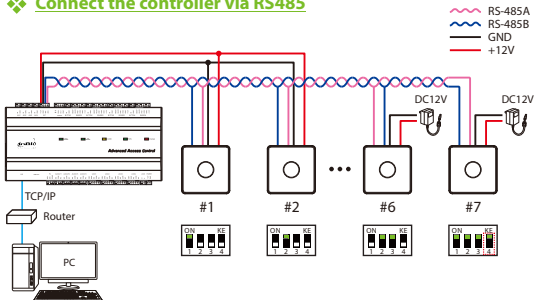

#### Notes:

1. A maximum of seven readers can be connected to one controller.
2. Before connecting RS-485 readers, open the rear panel of the reader and set the RS-485 address of the reader via DIP switch according to the connection of each reader.
3. If the RS-485 communication wire is longer than **100** meters, it is needed to set the 4th DIP switch of the last reader to **ON** state.
4. The DIP switch needs to be set with the controller powered off and takes effect after restart. After setting, the DIP switch does not need to be set back to its original position.



## ❖ Connect the controller via Wiegand

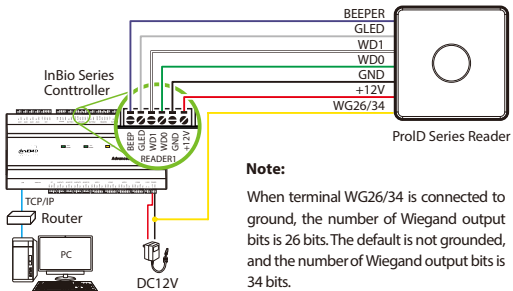

## 7. Access Control Device Connection

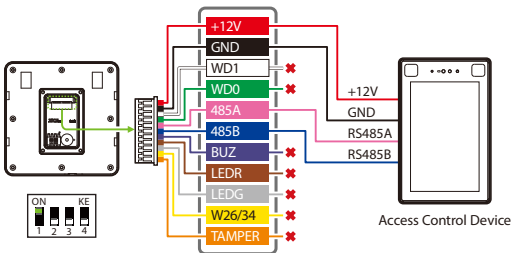

## 8. Tamper Switch Connection

When the tamper switch terminal is successfully connected to the controller, the device will sound an alarm when the back plate of the device is opened, and an alarm signal will be sent to the software side.

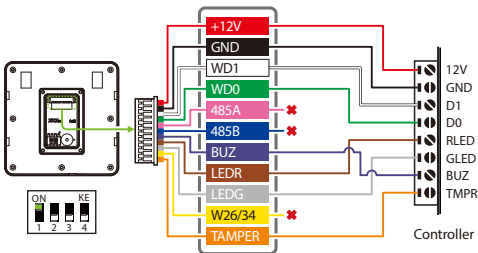

## 9. Power Connection

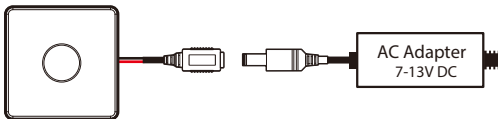

- Recommended AC adapter: **7 to 13V DC**, Current Draw > **350mA/5V**.
- Use an AC adapter with a higher current rating to share power with the other devices.

## 10. Buzzer, Indicator Light Prompt Instructions

When the ProID series reader works normally, the buzzer and indicator prompts are shown in the following table.

Working Status	Indicator Light	Buzzer
When the reader is powered on.	LED bright white light, then switch to white light breathing state after 0.4s.	1 short sound
When punching the card.	LED bright white light.	1 short sound
Card is registered	LED indicator lights green.	1 short sound
Card not registered	LED indicator (red) lights up briefly twice.	2 short sound

**Note:** In Wiegand communication mode, the status of LED and buzzer is controlled by the host when the card is swiped.

## 11. Specifications

Operation Voltage	7 to 13V DC
Current Draw	≤350mA 5V
Processor	32-bit ARM Cortex-M0 48MHz
Card Type	ID/IC Card
Read Range	0 to 3 cm
Output Format	Wiegand 26bit or 34bit (Adjustable), RS485
Operating Temperature	-20 °C to 65 °C
Operating Humidity	10% to 90% RH, Non-Condensing
Protection Rating	IP65, IK04
Installation	Asian gang box, single gang box, mullion mount
Color	Black & White
Certification	ISO9001, ISO14001, CE, FCC

# Green Label

ZKTeco Industrial Park, No. 32, Industrial Road,  
Tangxia Town, Dongguan, China.

Phone : +86 769 - 82109991

Fax : +86 755 - 89602394

[www.zkteco.com](http://www.zkteco.com)



Copyright © 2023 ZKTECO CO., LTD. All Rights Reserved.